

# Niwa

Design Robby Cantarutti & Partners



<sup>IT</sup> Realizzata in alluminio pressofuso ed estruso, la collezione di sedie da esterno Niwa si distingue per le sue linee nette e pulite, da apprezzare in versione “nuda” oppure con l’aggiunta di cuscini. La sua versatilità cromatica la rende adattabile a ogni gusto e a ogni contesto, sia residenziale che contract.

<sup>EN</sup> Made in die cast and extruded aluminium, the Niwa modern outdoor chairs and stools collection stands out for its crisp, clean-cut silhouettes, which can be appreciated in the “bare” version or with the addition of cushions. Its chromatic versatility means it can blend in with any taste and setting, in both residential and contract sectors.

## Descrizione / Description

## Misure / Quotes

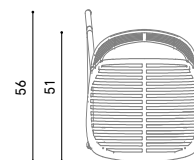
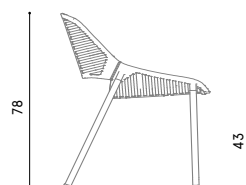
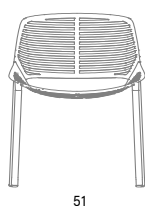
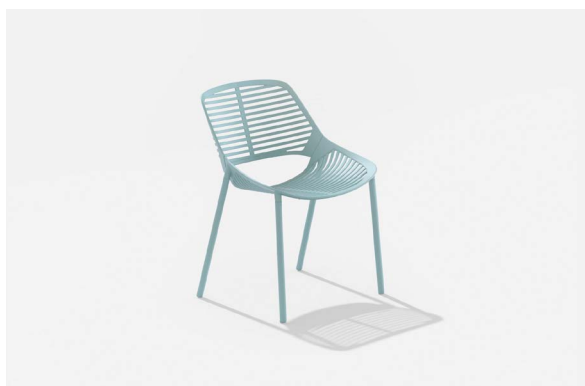

## Caratteristiche / Characteristics

Sedia in alluminio verniciato / Chair in painted aluminium

## Design / Design

Robby Cantarutti &amp; Partners | 2014

## Dimensioni / Dimensions

51 x 51 x 78/43 h

## Esterno / Outdoor

Sì / yes

## Struttura / Structure

Alluminio pressofuso e estruso / Die-cast and extruded aluminium

## Elementi plastici / Plastic elements

Elastomero termoplastico / Thermoplastics elastomer

## Finitura / Paint finishes

Verniciatura polveri poliestere o poliuretaniche / Paint finish with polyester or polyurethane powders

## Impilabilità / Stackability

No

## Viterie assemblaggio / Assembly screws

Acciaio inox / Stainless steel

## Peso netto singolo pezzo / Net weight

5,462 kg

## Pezzi per scatola / Units per package

4 disassemblati / 4 disassembled

## Dimensione e volume imballo / Packaging dimension and volume

53 x 73 x 88 cm 0.340 m<sup>3</sup>

## Peso lordo imballo / Gross weight package

28 kg

## Garanzia / Quality guarantee

2 anni / 2 years

## Accessori



619



620

## Descrizione / Description

## Misure / Quotes

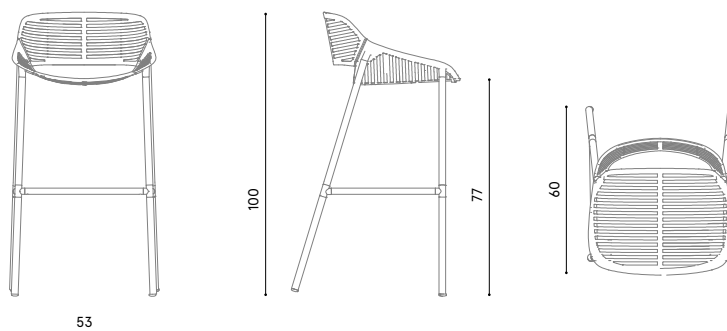
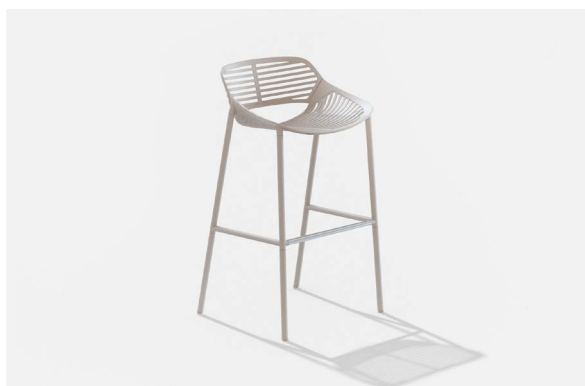

## Caratteristiche / Characteristics

Sgabello in alluminio verniciato con poggiapiedi in acciaio inox lucidato / Stool in painted aluminium with footrest in polished stainless steel

## Design / Design

Robby Cantarutti & Partners | 2014

## Dimensioni / Dimensions

53 x 60 x 100/77 h

## Esterno / Outdoor

Si / yes

## Struttura / Structure

Alluminio pressofuso, estruso, acciaio inox e ottone / Die-cast, extruded aluminium, stainless steel and brass

## Elementi plastici / Plastic elements

Elastomero termoplastico / Thermoplastics elastomer

## Finitura / Paint finishes

Verniciatura polveri poliestere o poliuretaniche / Paint finish with polyester or polyurethane powders

## Impilabilità / Stackability

No

## Viterie assemblaggio / Assembly screws

Acciaio inox / Stainless steel

## Peso netto singolo pezzo / Net weight

7,948 kg

## Pezzi per scatola / Units per package

1 assemblati / 1 assembled

## Dimensione e volume imballo / Packaging dimension and volume

54 x 63 x 108 cm 0.367 m<sup>3</sup>

## Peso lordo imballo / Gross weight package

11 kg

## Garanzia / Quality guarantee

2 anni / 2 years



620

## Descrizione / Description

## Misure / Quotes

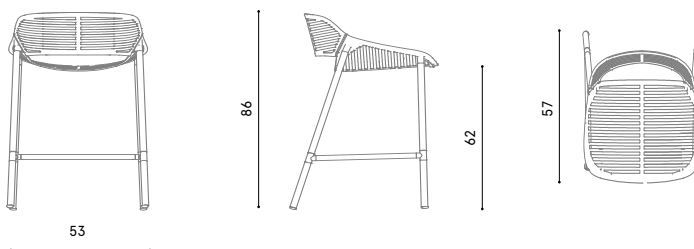

## Caratteristiche / Characteristics

Sgabello in alluminio verniciato con poggiapiedi in acciaio inox lucidato / Stool in painted aluminium with footrest in polished stainless steel

Design / Design	Robby Cantarutti & Partners   2014	
Dimensioni / Dimensions	53 x 57 x 86/62 h	
Esterno / Outdoor	Sì / yes	
Struttura / Structure	Alluminio pressofuso, estruso, acciaio inox e ottone / Die-cast, extruded aluminium, stainless steel and brass	
Elementi plastici / Plastic elements	Polipropilene ed elastomero termoplastico / Polypropylene and thermoplastics elastomer	
Finitura / Paint finishes	Verniciatura polveri poliesteri o poliuretaniche / Paint finish with polyester or polyurethane powders	
Impilabilità / Stackability	No	
Viterie assemblaggio / Assembly screws	Acciaio inox / Stainless steel	
Peso netto singolo pezzo / Net weight	7,561 kg	
Pezzi per scatola / Units per package	1 assemblati / 1 assembled	
Dimensione e volume imballo / Packaging dimension and volume	54 x 73 x 88 cm	0,346 m <sup>3</sup>
Peso lordo imballo / Gross weight package	10,5 kg	
Garanzia / Quality guarantee	2 anni / 2 years	



620

## Manutenzione / Maintenance

**Alluminio verniciato:** Le operazioni di ordinaria pulizia per l'alluminio verniciato vanno eseguite con acqua tiepida e detergente neutro, utilizzando un panno morbido, evitando l'utilizzo di prodotti abrasivi, aggressivi, a base acida o alcalina.

**Painted Aluminium:** Perform routine cleaning on painted aluminium with warm water and neutral detergent, using a soft cloth. Do not use aggressive, abrasive, acid- or alkalibased products.